

Main

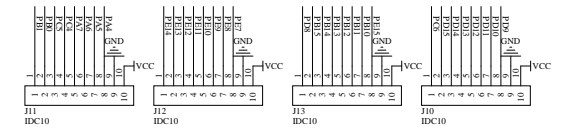

Title		
Size	Number	Revision
A2		
Date:	09.11.2017	Sheet: 4 of 4
File:	D:\Hobby\STM32F4\EvaluationBoardM2296\Brd15v	Sheet: 4 of 4

Power

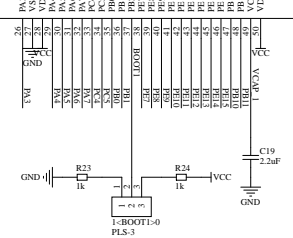
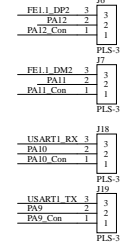
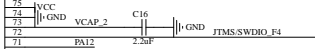
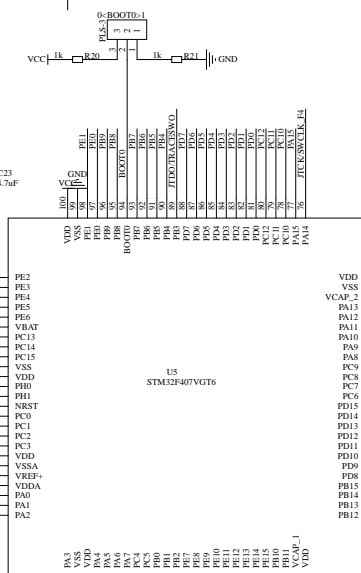
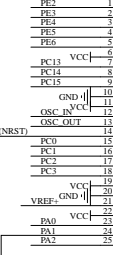
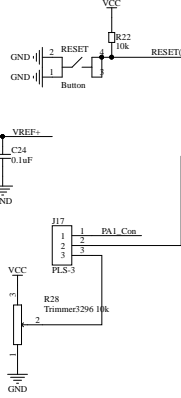
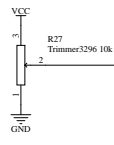
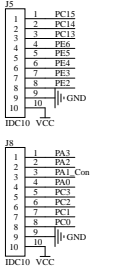
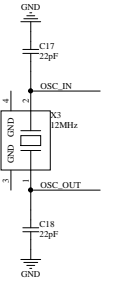
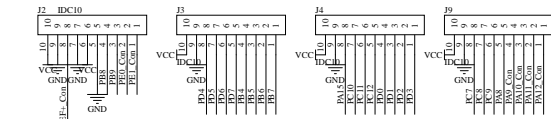
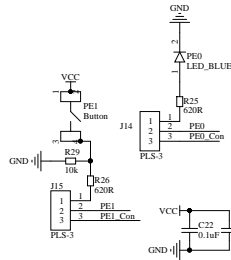
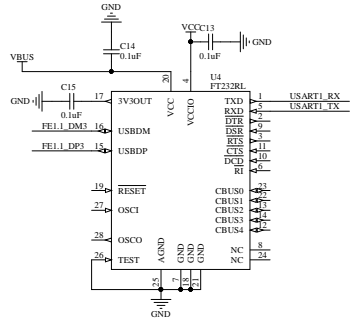
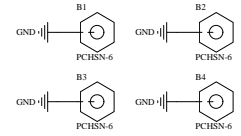
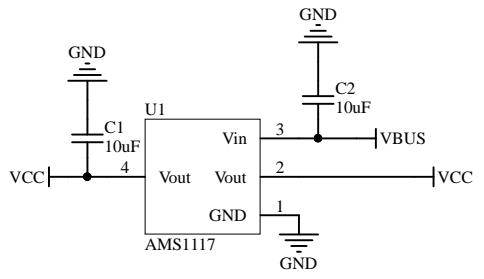
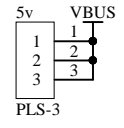
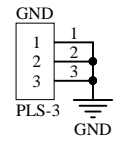
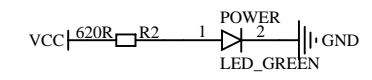

Title		
Size A4	Number	Revision
Date:	09.11.2017	Sheet of
File:	D:\Hobby\...\STM32F4EvaluationBoardPowerSchDoc	

ST-Link

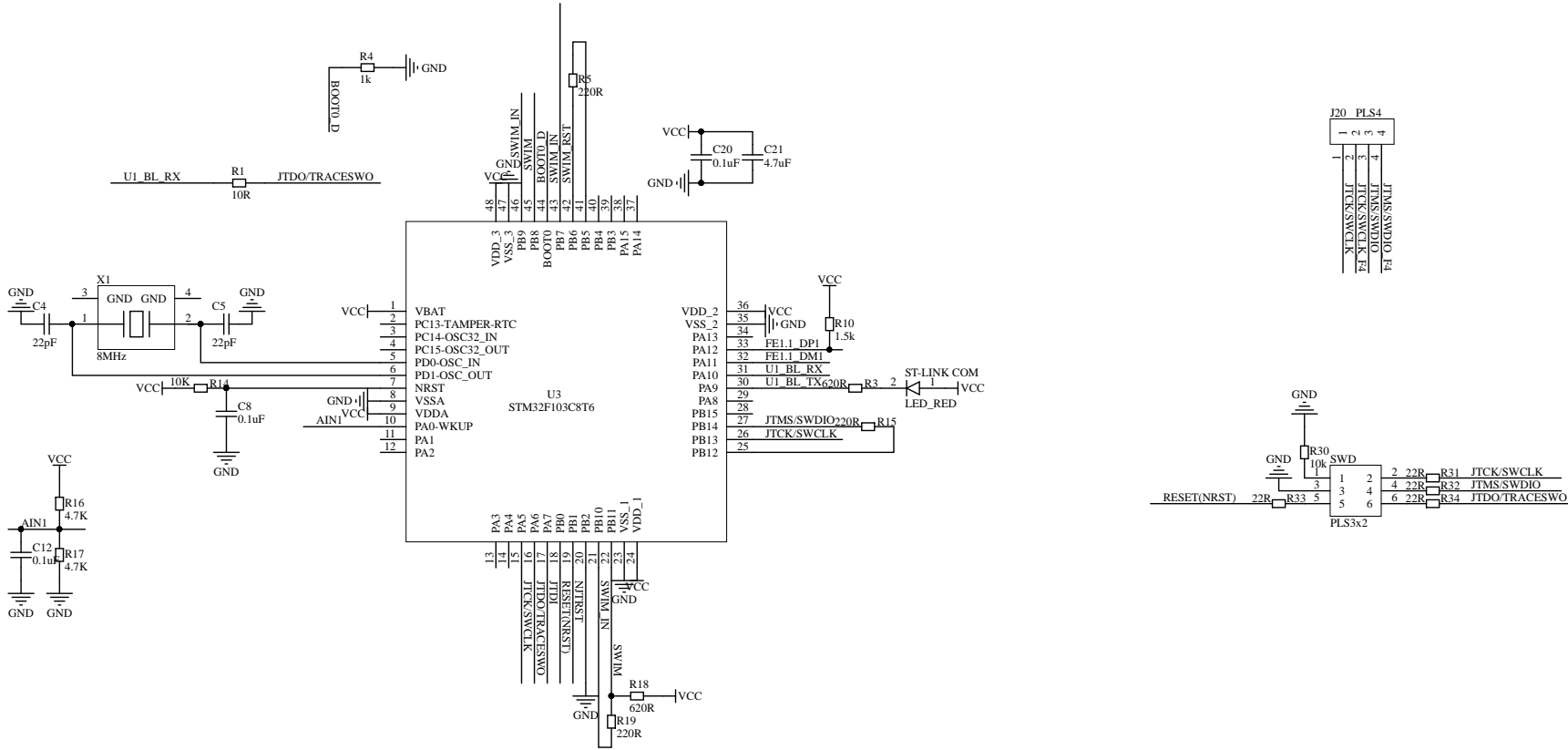

Title		
Size	Number	Revision
A3		
Date:	09.11.2017	Sheet of
File:	D:\Hobby\...\STM32F4EvaluationBoardS...	8/8

USB-HUB

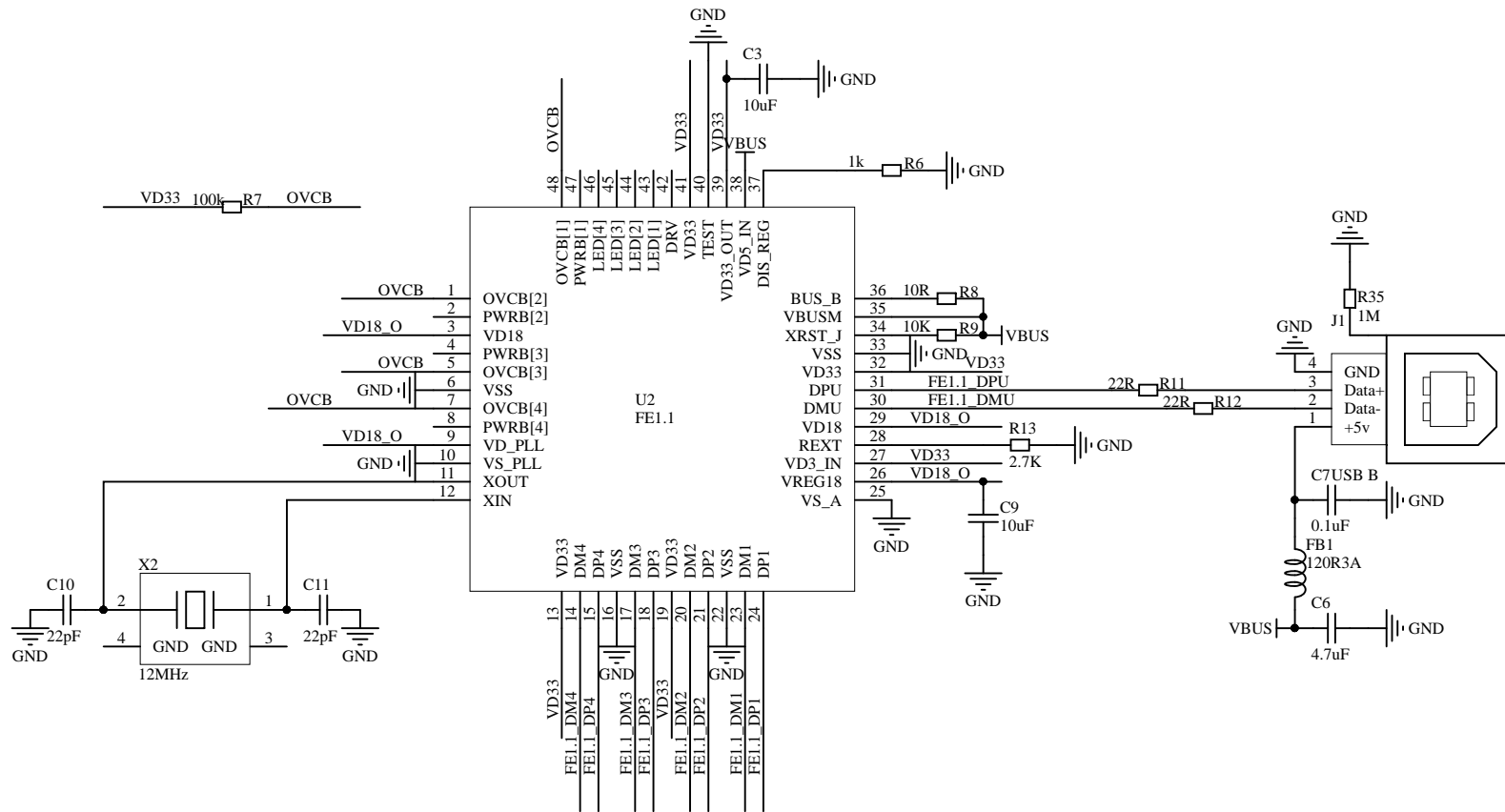

Title		
Size	Number	Revision
A4		
Date:	09.11.2017	Sheet of
File:	D:\Hobby\...STM32F4EvaluationBoardUSB-HUB\SCH.SchDoc	